



# ULTRA:LED 3.0

## Výhody

- Vysoká světelná účinnost až 170lm/W
- Záruka až 10 let
- Difuzor z kaleného skla nebo PMMA
- Tělo z hliníku - lepší odvod tepla
- Okolní teplota až +65 stC



### Ultra:LED 3.0 I

	P	lm	K	Ra	IP		
ULT3-I-WW	53	8750	3000K	>80	65	60°, 90°	4,4kg
ULT3-I-NW	53	9200	4000K	>80	65	60°, 90°	4,4kg
ULT3-I-DW	53	9250	5000K	>80	65	60°, 90°	4,4kg

### Ultra:LED 3.0 II

	P	lm	K	Ra	IP		
ULT3-II-WW	83	12900	3000K	>80	65	60°, 90°	4,4kg
ULT3-II-NW	83	13650	4000K	>80	65	60°, 90°	4,4kg
ULT3-II-DW	83	13700	5000K	>80	65	60°, 90°	4,4kg









### Ultra:LED 3.0 III

	P	lm	K	Ra	IP		
ULT3-III-WW	110	17050	3000K	>80	65	60°, 90°	6,1kg
ULT3-III-NW	110	18100	4000K	>80	65	60°, 90°	6,1kg
ULT3-III-DW	110	18150	5000K	>80	65	60°, 90°	6,1kg









### Ultra:LED 3.0 IV

	P	lm	K	Ra	IP		
ULT3-IV-WW	145	21450	3000K	>80	65	60°, 90°	6,1kg
ULT3-IV-NW	145	22750	4000K	>80	65	60°, 90°	6,1kg
ULT3-IV-DW	145	22800	5000K	>80	65	60°, 90°	6,1kg

## Ultra:LED 3.0 V

							
ULT3-V-WW	195	29750	3000K	>80	65	60°, 90°	9,3kg
ULT3-V-NW	195	31350	4000K	>80	65	60°, 90°	9,3kg
ULT3-V-DW	195	31400	5000K	>80	65	60°, 90°	9,3kg



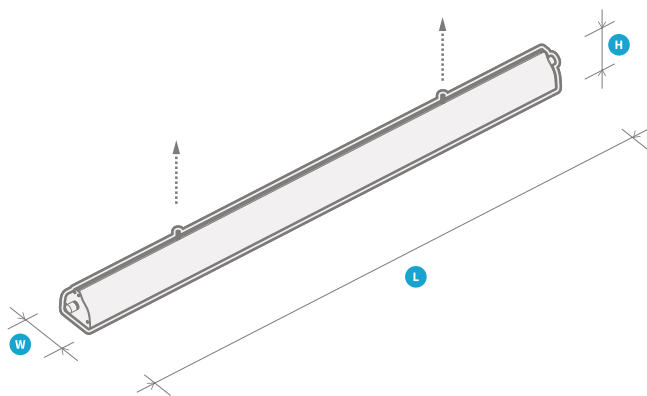

## Ultra:LED 3.0 VI

							
ULT3-VI-WW	260	39800	3000K	>80	65	60°, 90°	12kg
ULT3-VI-NW	260	41950	4000K	>80	65	60°, 90°	12kg
ULT3-VI-DW	260	42000	5000K	>80	65	60°, 90°	12kg

## Rozměry a logistika



	H	L	W
ULT3-I	96	910	95
ULT3-II	96	910	95
ULT3-III	96	1207	95
ULT3-IV	96	1207	95
ULT3-V	96	1881	95
ULT3-VI	96	2461	95

			
ULT3-I	4	54	120x80
ULT3-II	4	54	120x80
ULT3-III	4	50	130x80
ULT3-IV	4	50	130x80
ULT3-V	3	40	200x80
ULT3-VI	2	36	300x80

## Montáž

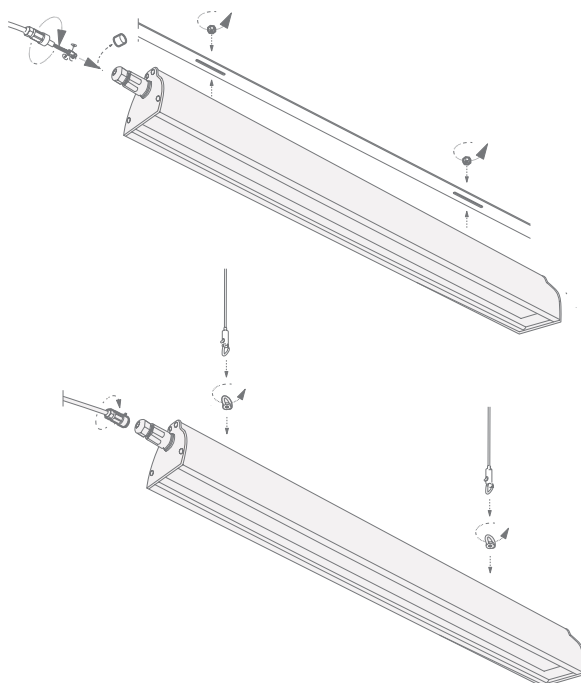

**přisazená SF**



**zavěšená SS**



# Křivky svítivosti

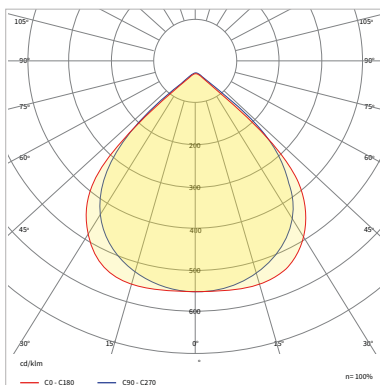
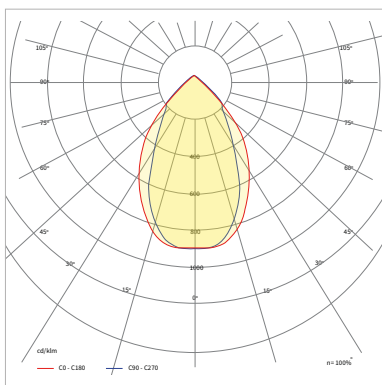

## Dostupné konfigurace



Rozměr	I	II	III	IV	V	VI
1 Teplota barvy	WW 3000K		NW 4000K		DW 5000K	
2 Optika	60°		90°			
3 Difuzor	DT Transparentní PMMA		DGT Skleněný Transparentní		DGF Skleněný Matný	
4 Řízení	DALI DALI					
5 Příslušenství	96M 8 let záruka		120M 10 let záruka		PRO -35°C do +55°C	HPT -35°C do +65°C